

MBN1200H45E2-H

Silicon N-channel IGBT 4500V E2 version

FEATURES

- * Low switching loss IGBT module.
- * Low noise due to ultra soft fast recovery diode.
- * High reliability, high durability module.
- * High thermal fatigue durability.
($\Delta T_c=70^\circ\text{C}$, $N>30,000$ cycles)
- * Isolated heat sink (terminal to base).

ABSOLUTE MAXIMUM RATINGS ($T_c=25^\circ\text{C}$)

Item	Symbol	Unit	MBN1200H45E2-H
Collector Emitter Voltage	V_{CES}	V	4,500
Gate Emitter Voltage	V_{GES}	V	± 20
Collector Current	DC	I_C	1,200 ($T_c=80^\circ\text{C}$)
	1ms	I_{Cp}	2,400
Forward Current	DC	I_F	1,200
	1ms	I_{FM}	2,400
Junction Temperature	T_j	$^\circ\text{C}$	-40 ~ +125
Maximum Junction Temperature	$T_{vj\max}$	$^\circ\text{C}$	150 (1)
Storage Temperature	T_{stg}	$^\circ\text{C}$	-50 ~ +125 (2)
Isolation Voltage	V_{ISO}	V_{RMS}	10,200 (AC 1 minute)
Screw Torque	Terminals (M4/M8)	-	2/10 (3)
	Mounting (M6)	-	6 (4)

Notes: (1) Regarding the definition of $T_{vj\max}$ for each operation mode, please refer to LD-ES-130737.

(2) Terminal temperature shall not exceed the specified temperature in any operation.

(3) Recommended Value $1.8\pm 0.2/9\pm 1\text{N}\cdot\text{m}$ (4) Recommended Value $5.5\pm 0.5\text{N}\cdot\text{m}$

ELECTRICAL CHARACTERISTICS

Item	Symbol	Unit	Min.	Typ.	Max.	Test Conditions	
Collector Emitter Cut-Off Current	I_{CES}	mA	-	-	5	$V_{CE}=4,500\text{V}$, $V_{GE}=0\text{V}$, $T_j=25^\circ\text{C}$	
			-	25	100	$V_{CE}=4,500\text{V}$, $V_{GE}=0\text{V}$, $T_j=125^\circ\text{C}$	
Gate Emitter Leakage Current	I_{GES}	nA	-500	-	+500	$V_{GE}=\pm 20\text{V}$, $V_{CE}=0\text{V}$, $T_j=25^\circ\text{C}$	
Collector Emitter Saturation Voltage	$V_{CE(sat)}$	V	3.5	4.2	4.7	$I_C=1200\text{A}$, $V_{GE}=15\text{V}$, $T_j=125^\circ\text{C}$	
Gate Emitter Threshold Voltage	$V_{GE(TO)}$	V	5.4	6.4	7.4	$V_{CE}=10\text{V}$, $I_C=1200\text{mA}$, $T_j=25^\circ\text{C}$	
Input Capacitance	C_{ies}	nF	-	165	-	$V_{CE}=10\text{V}$, $V_{GE}=0\text{V}$, $f=100\text{kHz}$, $T_j=25^\circ\text{C}$	
Internal Gate Resistance	R_{ge}	Ω	-	0.8	-	$V_{CE}=10\text{V}$, $V_{GE}=0\text{V}$, $f=100\text{kHz}$, $T_j=25^\circ\text{C}$	
Switching Times	Rise Time	t_r	1.0	2.1	4.2	$V_{CC}=2,600\text{V}$, $I_C=1200\text{A}$	
	Turn On Time	t_{on}	1.3	2.7	5.4	$L_s=150\text{nH}$	
	Fall Time	t_f	1.2	2.4	3.6	$R_g=3.3\Omega$ (5)	
	Turn Off Time	t_{off}	2.4	4.8	7.2	$V_{GE}=\pm 15\text{V}$, $T_j=125^\circ\text{C}$	
Peak Forward Voltage Drop	V_{FM}	V	3.0	3.7	4.2	$I_F=1200\text{A}$, $V_{GE}=0\text{V}$, $T_j=125^\circ\text{C}$	
Reverse Recovery Time	t_{rr}	μs	0.3	0.7	1.4	$V_{CC}=2600\text{V}$, $I_F=1200\text{A}$, $L_s=150\text{nH}$ $T_j=125^\circ\text{C}$	
Turn On Loss	$E_{on(10\%)}$	J/p	-	3.2	4.8	$V_{CC}=2600\text{V}$, $I_C=I_F=1200\text{A}$, $L_s=150\text{nH}$ $R_g=3.3\Omega$ (5) $V_{GE}=\pm 15\text{V}$, $T_j=125^\circ\text{C}$	
	$E_{on(full)}$		-	3.8	-		
Turn Off Loss	$E_{off(10\%)}$	J/p	-	3.2	4.8		
	$E_{off(full)}$		-	3.8	-		
Reverse Recovery Loss	$E_{rr(10\%)}$	J/p	-	2.5	3.7		
	$E_{rr(full)}$		-	2.8	-		
Thermal Impedance	IGBT	$R_{th(j-c)}$	K/W	-	-	0.0085	
	FWD	$R_{th(j-c)}$		-	-		0.017
Contact Thermal Impedance		$R_{th(c-f)}$	K/W	-	0.005	-	Case to fin ($\lambda_{grease}=1\text{W}/(\text{m}\cdot\text{K})$, Heat-sink flatness $\leq 50\mu\text{m}$)

Notes:(5) R_g value is the test condition's value for evaluation of the switching times, not recommended value.

Please, determine the suitable R_g value after the measurement of switching waveforms (overshoot voltage, etc.) with appliance mounted.

- * Please contact our representatives at order.
- * For improvement, specifications are subject to change without notice.
- * For actual application, please confirm this spec sheet is the newest revision.

MBN1200H45E2-H

DEFINITION OF TEST CIRCUIT

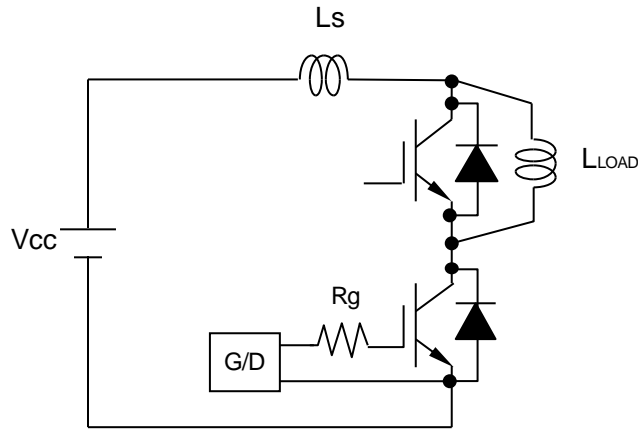

Fig.1 Switching test circuit

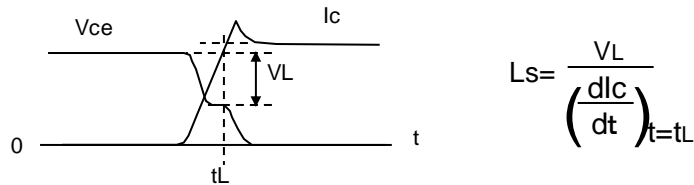

Fig.2 Definition of Ls

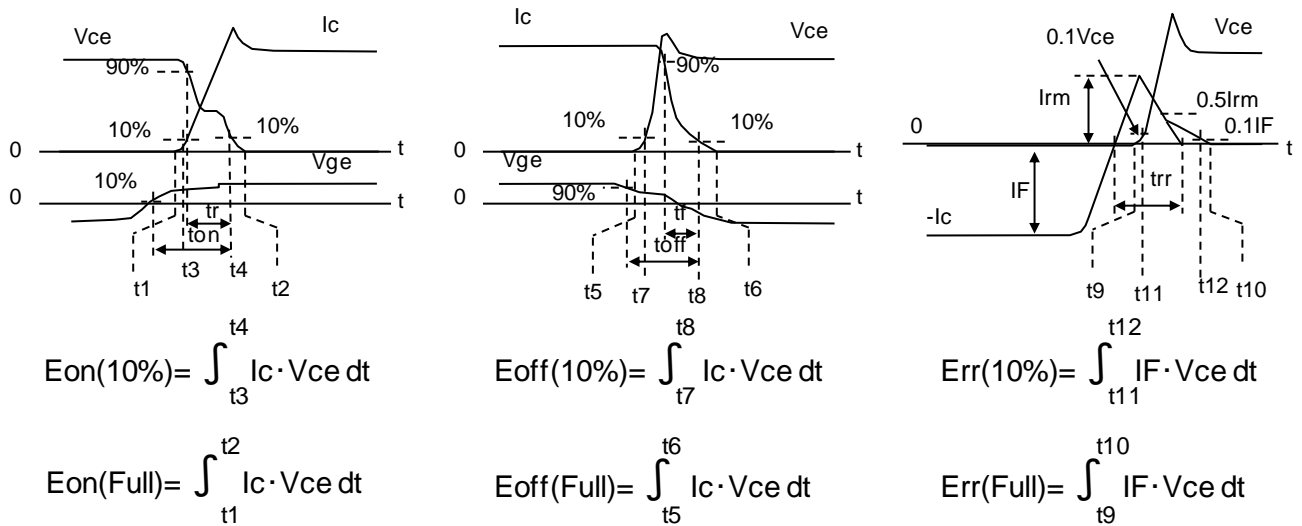
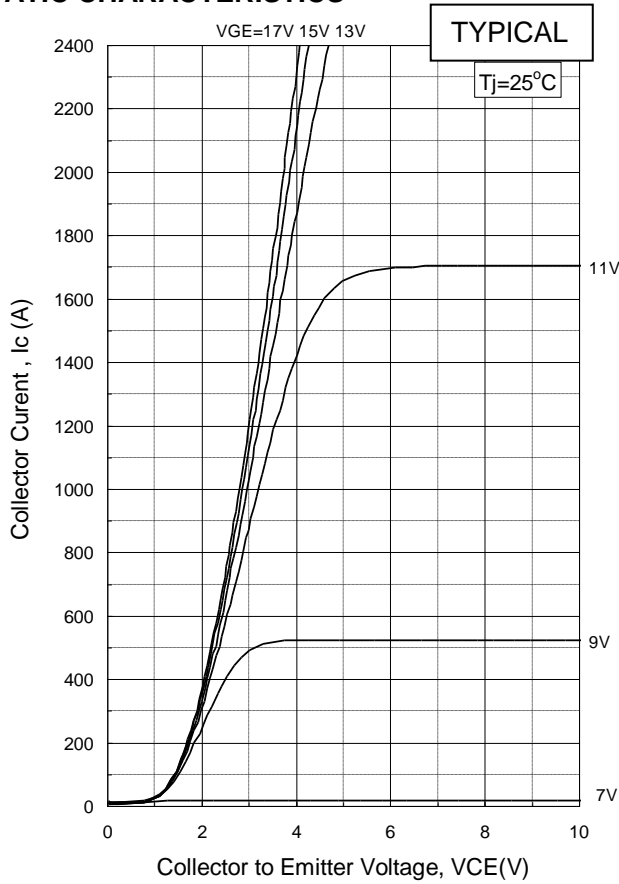

Fig.3 Definition of switching loss

MBN1200H45E2-H

STATIC CHARACTERISTICS



Ic vs. VCE(Tj=25°C)

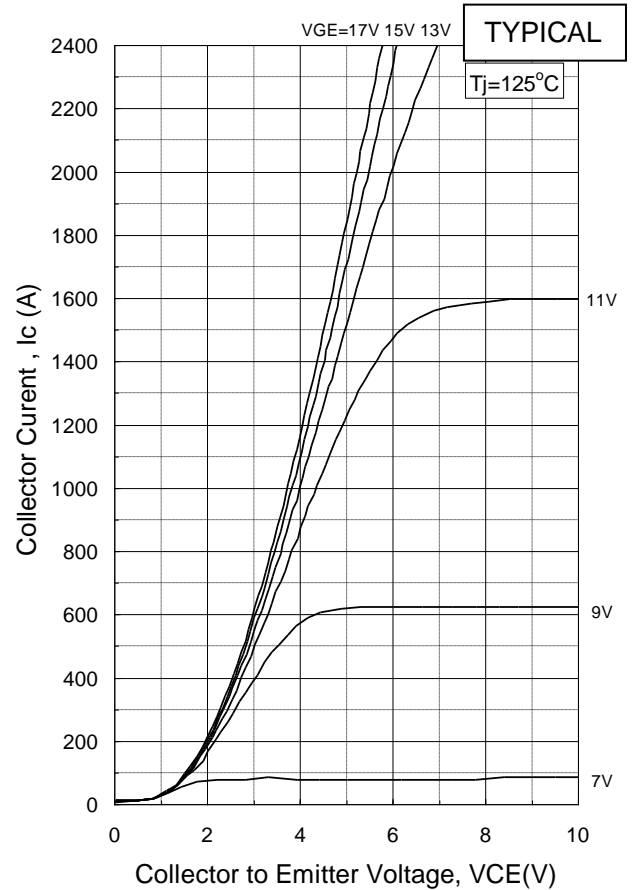

Ic vs. VCE(Tj=125°C)

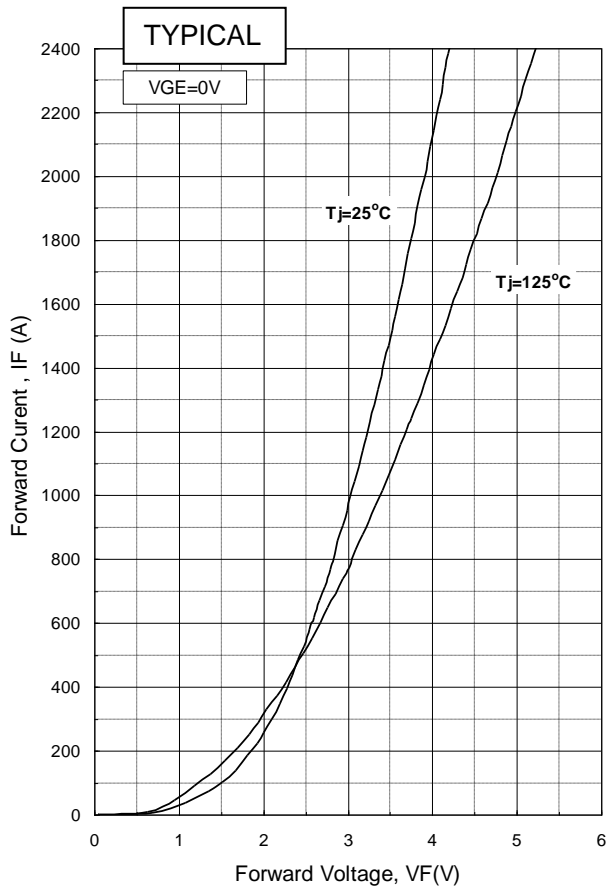

IF vs. VF

MBN1200H45E2-H

DYNAMIC CHARACTERISTICS

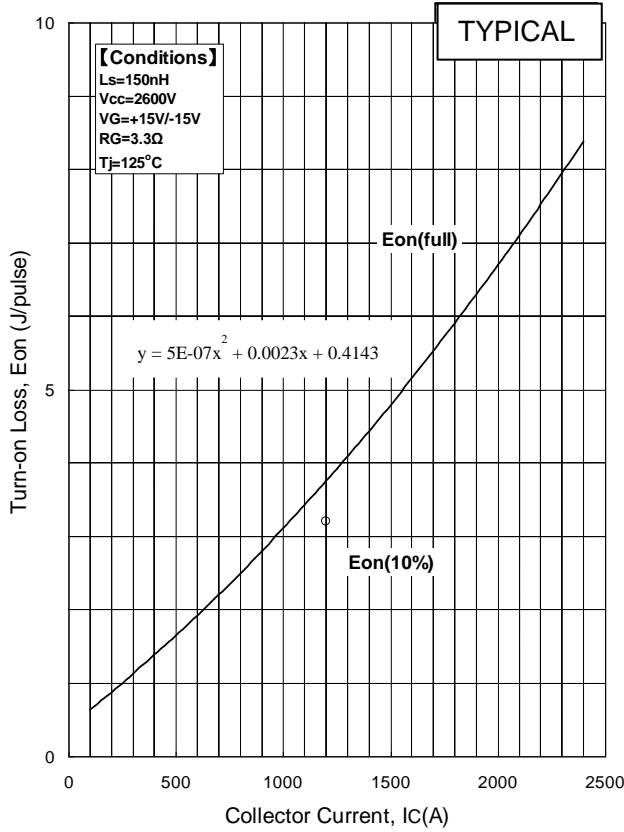

Turn-on loss vs. Collector current

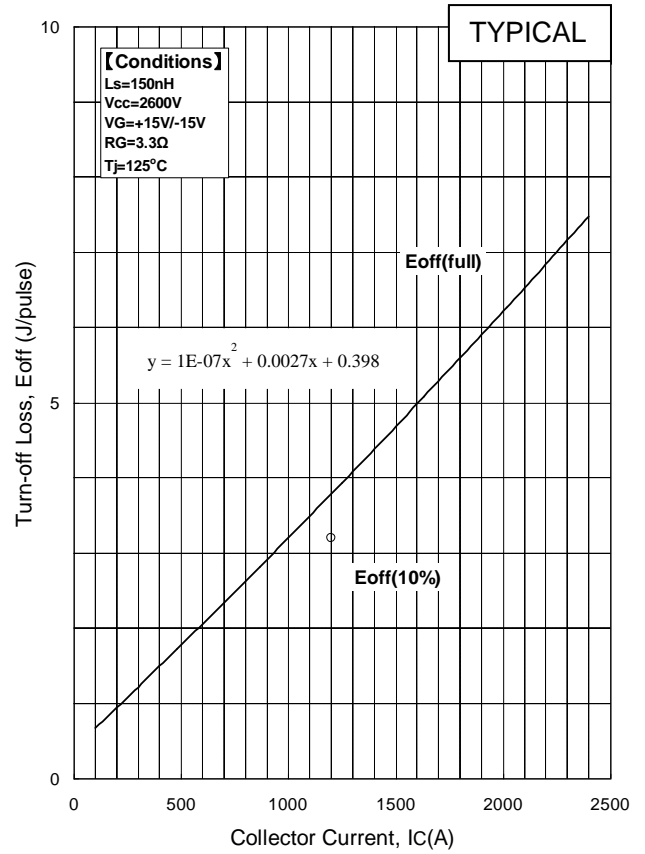

Turn-off loss vs. Collector current

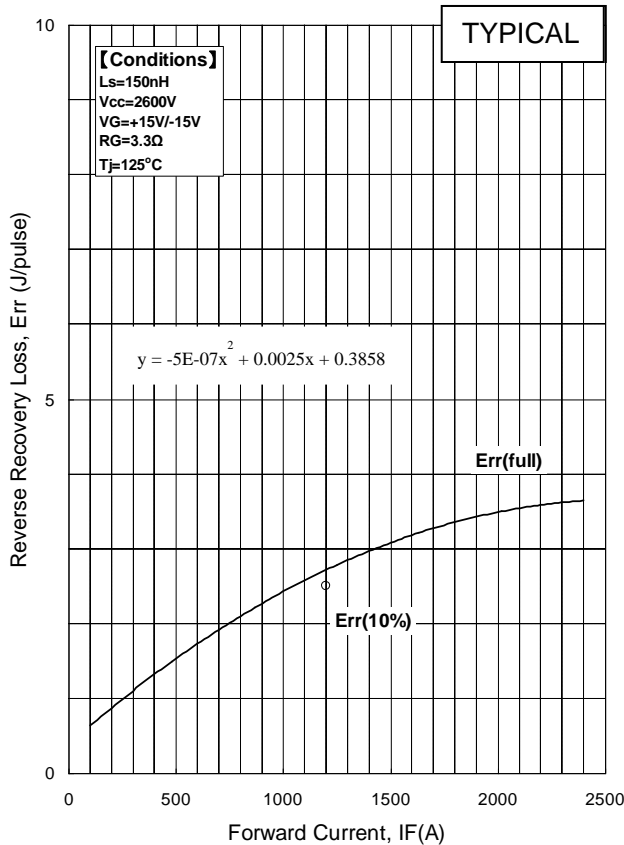

Recovery loss vs. Forward current

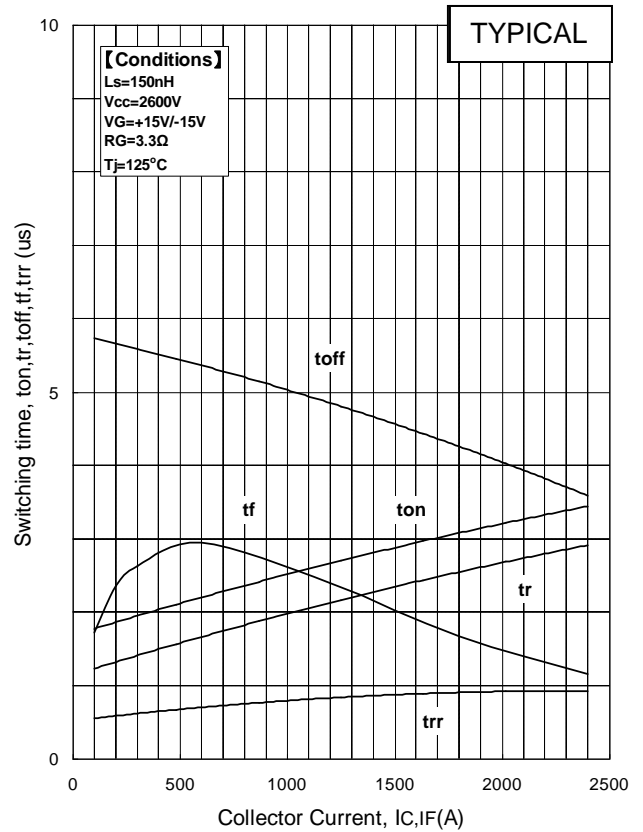

Switching time vs. Collector current

MBN1200H45E2-H

DYNAMIC CHARACTERISTICS

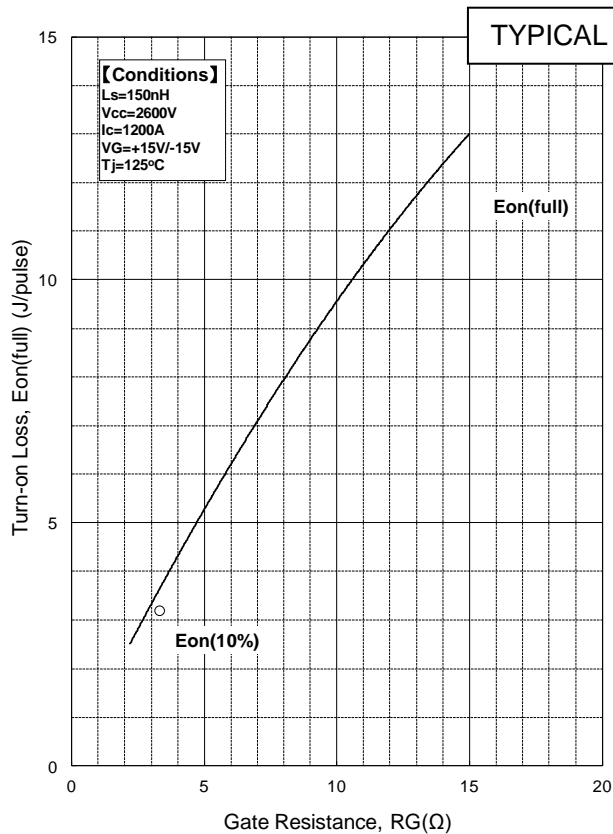

Turn-on loss vs. Gate Resistance

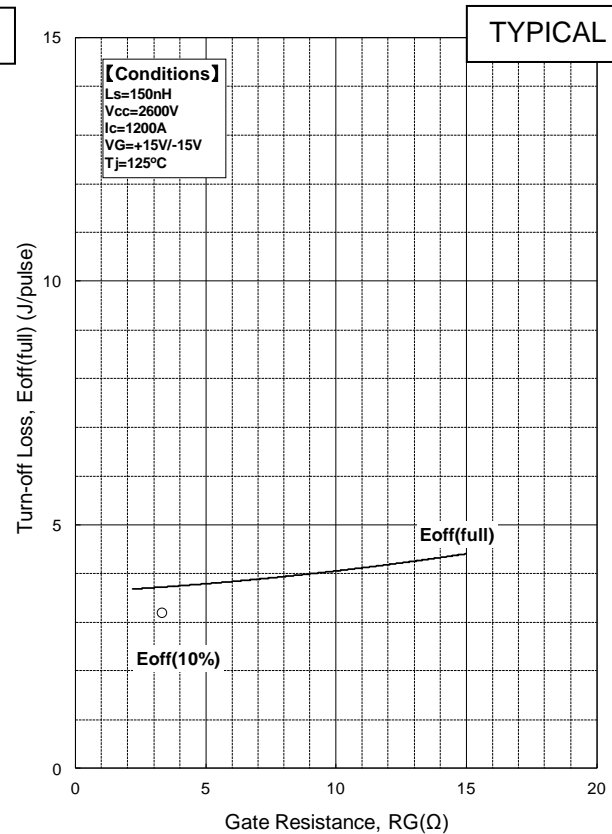

Turn-off loss vs. Gate Resistance

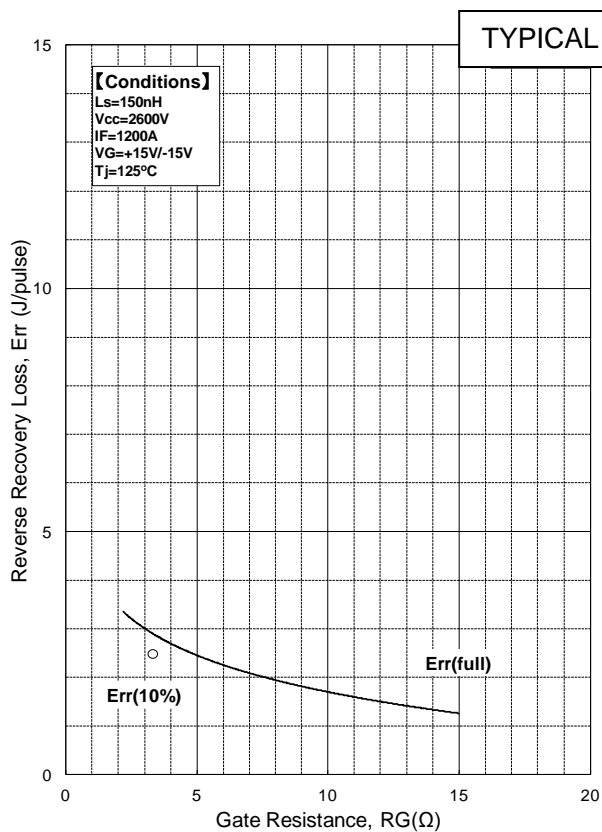

Recovery loss vs. Gate Resistance

MBN1200H45E2-H

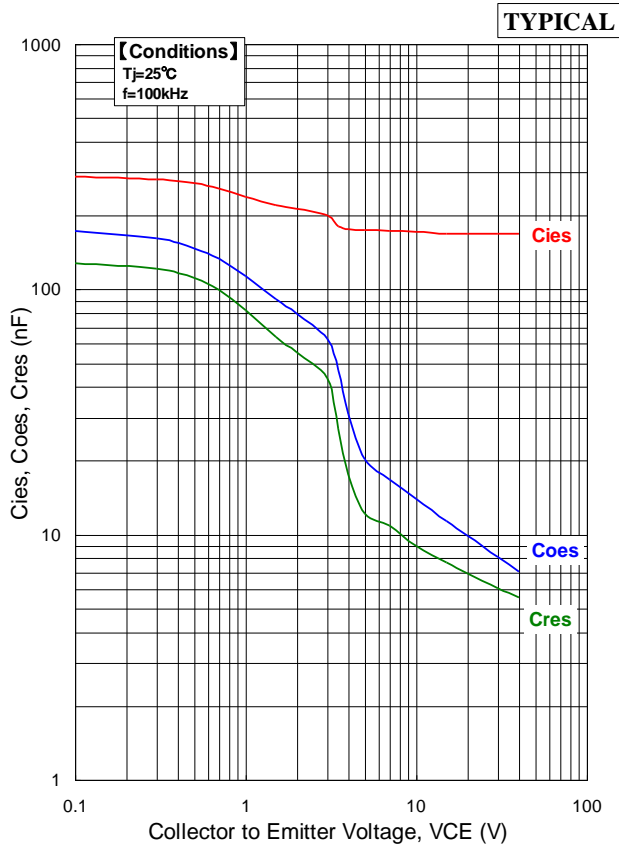

Cies, Coes, Cres - VCE

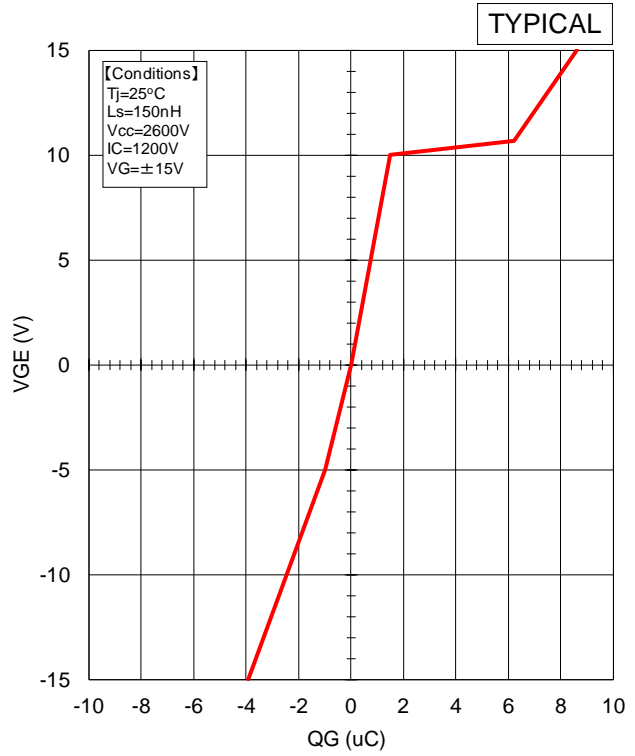

QG - VGE

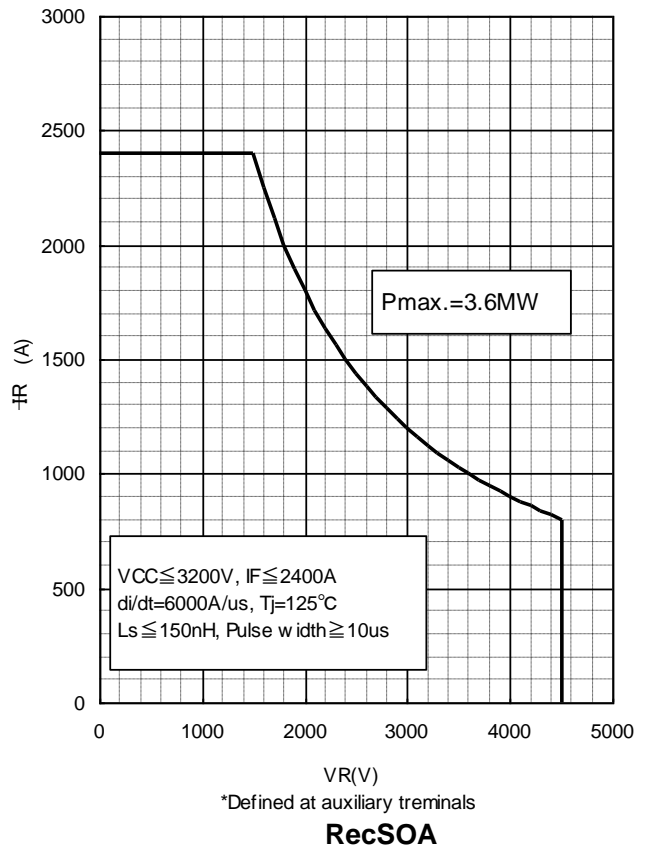
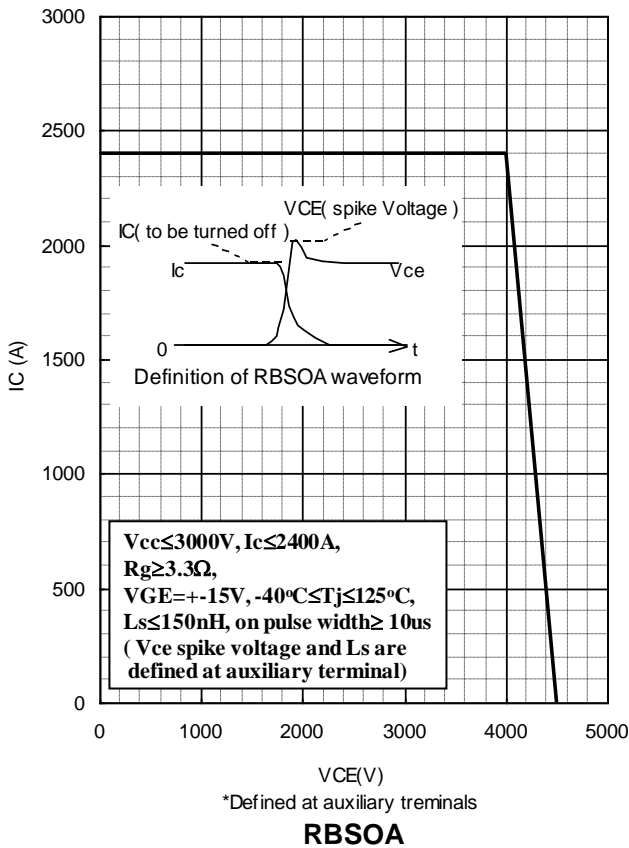

MBN1200H45E2-H

TRANSIENT THERMAL IMPEDANCE

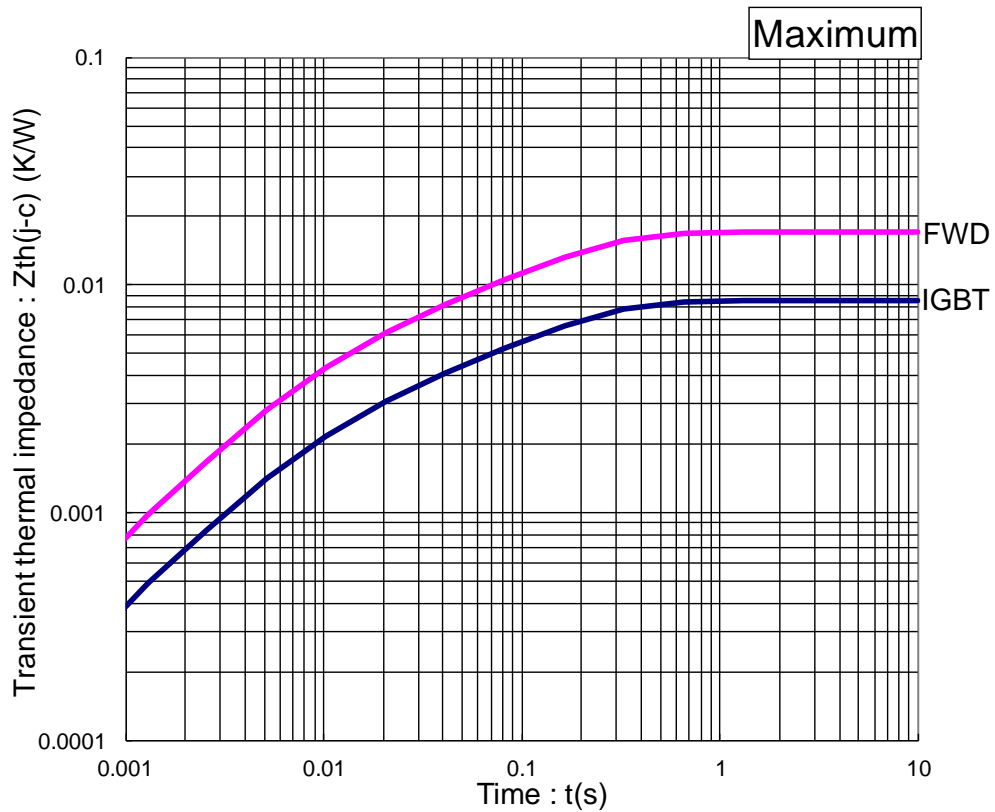

Transient Thermal Impedance Curve

Curve Approximation Model

$$\sum r_{th}[n] * (1 - \exp(-t/r_{th}[n]))$$

n	1	2	3	4	Unit
$\tau_{th}[n]$	1.63E-01	2.71E-02	6.12E-03	8.66E-04	sec
$r_{th}[n,IGBT]$	5.24E-03	1.61E-03	1.56E-03	8.64E-05	K/W
$r_{th}[n,Diode]$	1.05E-02	3.18E-03	3.13E-03	1.71E-04	K/W

Material declaration

Please note that following materials are contained in the product In order to keep characteristics and reliability level.

Material	Contained part
Lead (Pb) and its compounds	Solder

MBN1200H45E2-H

Module Outline Drawing

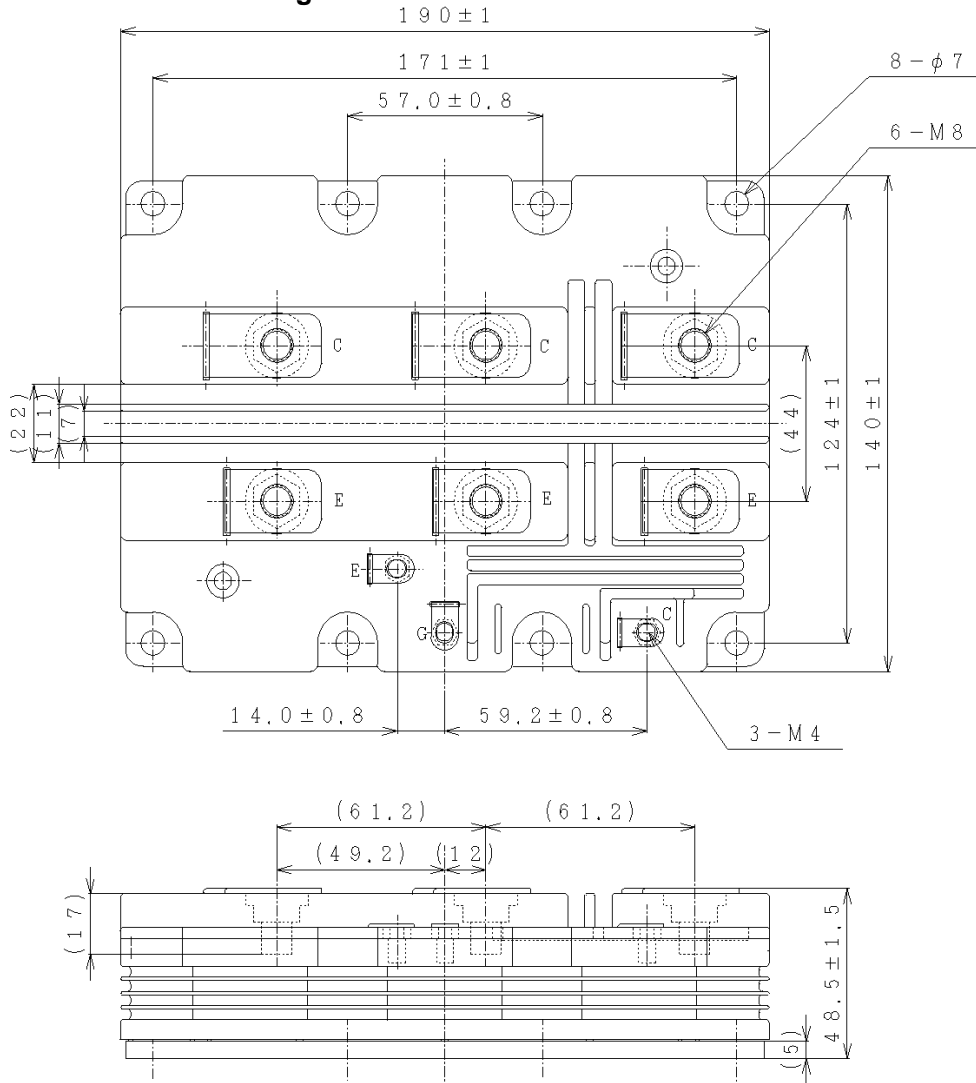

Unit: mm

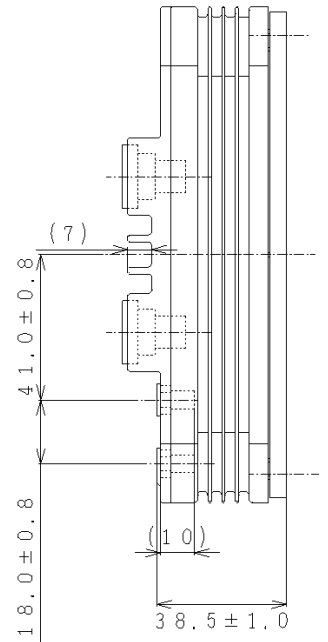

Weight: 1550(g)

CIRCUIT DIAGRAM

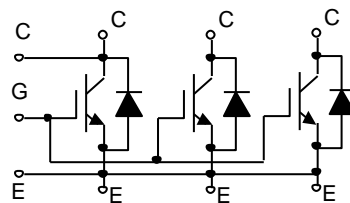

TERMINALS

MBN1200H45E2-H

HITACHI POWER SEMICONDUCTORS

Notices

1. The information given herein, including the specifications and dimensions, is subject to change without prior notice to improve product characteristics. Before ordering, purchasers are advised to contact Hitachi sales department for the latest version of this data sheets.
2. Please be sure to read "Precautions for Safe Use and Notices" in the individual brochure before use.
3. In cases where extremely high reliability is required (such as use in nuclear power control, aerospace and aviation, traffic equipment, life-support-related medical equipment, fuel control equipment and various kinds of safety equipment), safety should be ensured by using semiconductor devices that feature assured safety or by means of users' fail-safe precautions or other arrangement. Or consult Hitachi's sales department staff.
4. In no event shall Hitachi be liable for any damages that may result from an accident or any other cause during operation of the user's units according to this data sheets. Hitachi assumes no responsibility for any intellectual property claims or any other problems that may result from applications of information, products or circuits described in this data sheets.
5. In no event shall Hitachi be liable for any failure in a semiconductor device or any secondary damage resulting from use at a value exceeding the absolute maximum rating.
6. No license is granted by this data sheets under any patents or other rights of any third party or Hitachi Power Semiconductor Device, Ltd.
7. This data sheets may not be reproduced or duplicated, in any form, in whole or in part, without the expressed written permission of Hitachi Power Semiconductor Device, Ltd.
8. The products (technologies) described in this data sheets are not to be provided to any party whose purpose in their application will hinder maintenance of international peace and safety not are they to be applied to that purpose by their direct purchasers or any third party. When exporting these products (technologies), the necessary procedures are to be taken in accordance with related laws and regulations.

- For inquiries relating to the products, please contact nearest overseas representatives that is located "Inquiry" portion on the top page of a home page.

Hitachi power semiconductor home page address <http://www.hitachi-power-semiconductor-device.co.jp/en/>